

Date: -----

Name: -----

Trace the letter

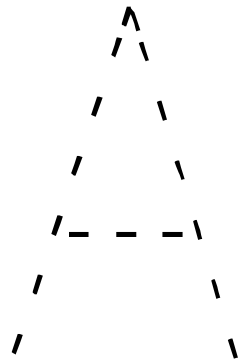
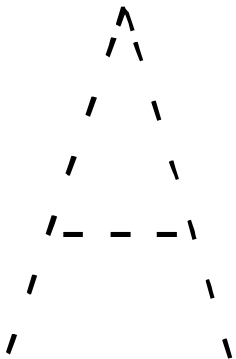
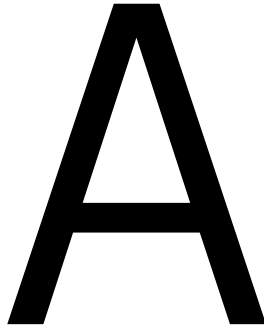
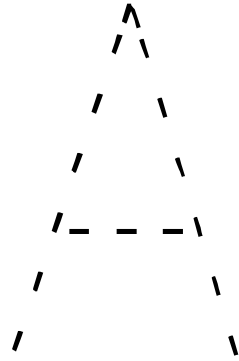
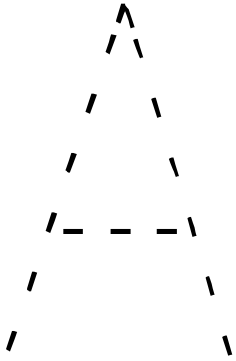

Name: _____

Date: _____

Color the drawing and trace the word

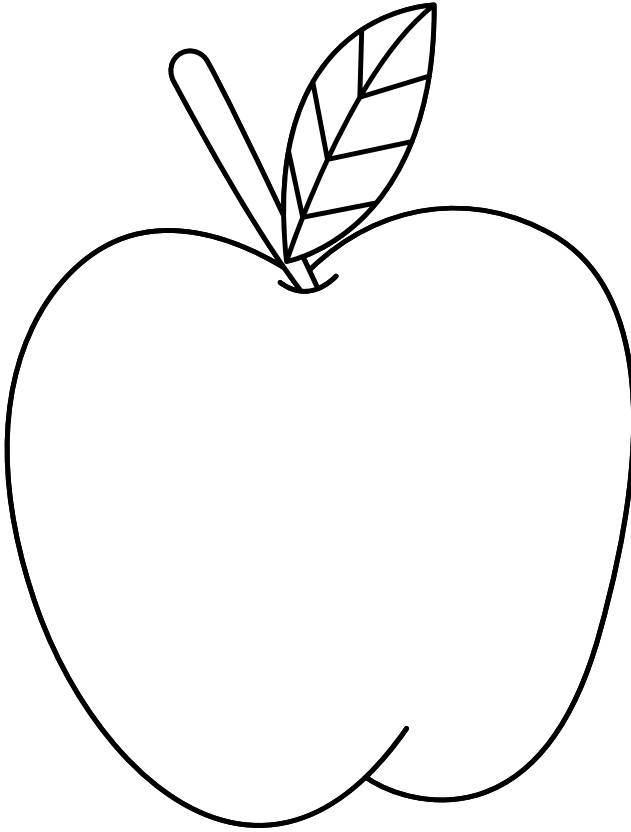

Apple

Date: -----

Name: -----

Trace the letter

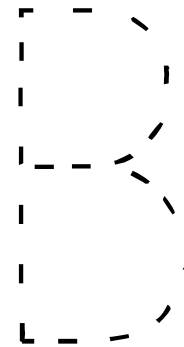
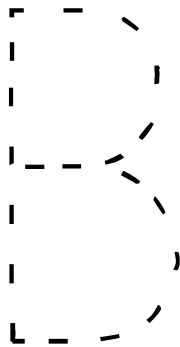
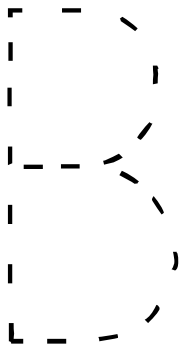
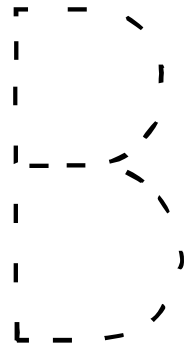
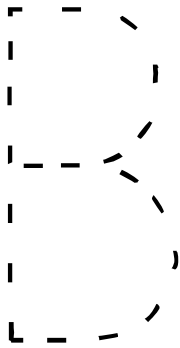

Name: _____

Date: _____

Color the drawing and trace the word

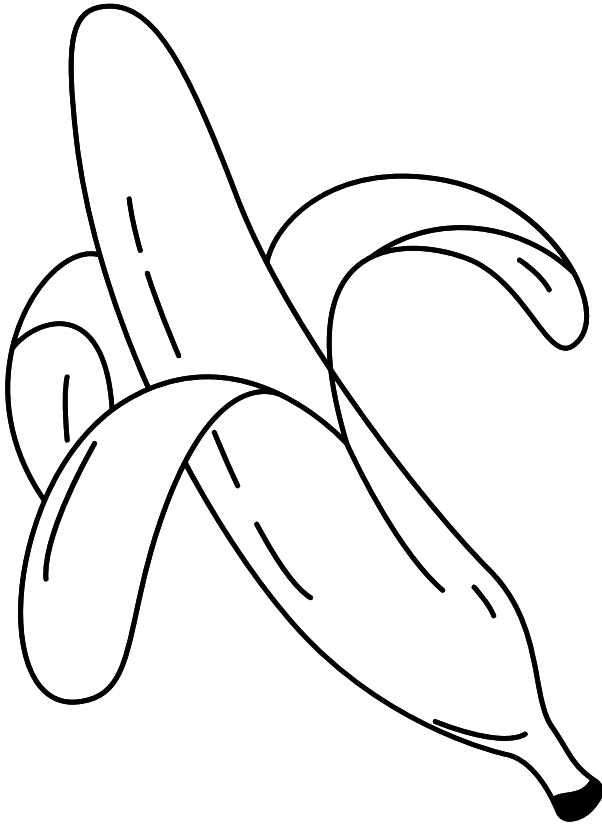

Banana

Date: -----

Name: -----

Trace the letter

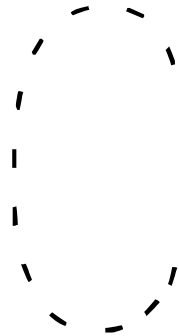
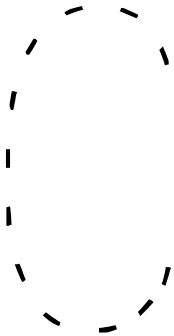
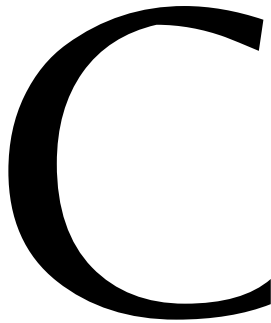
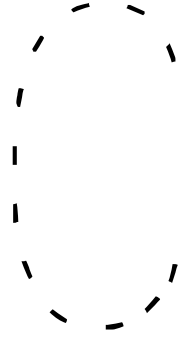
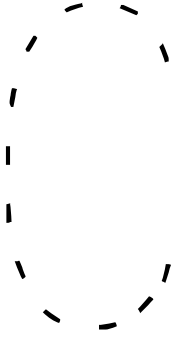

Name: _____

Date: _____

Color the drawing and trace the word

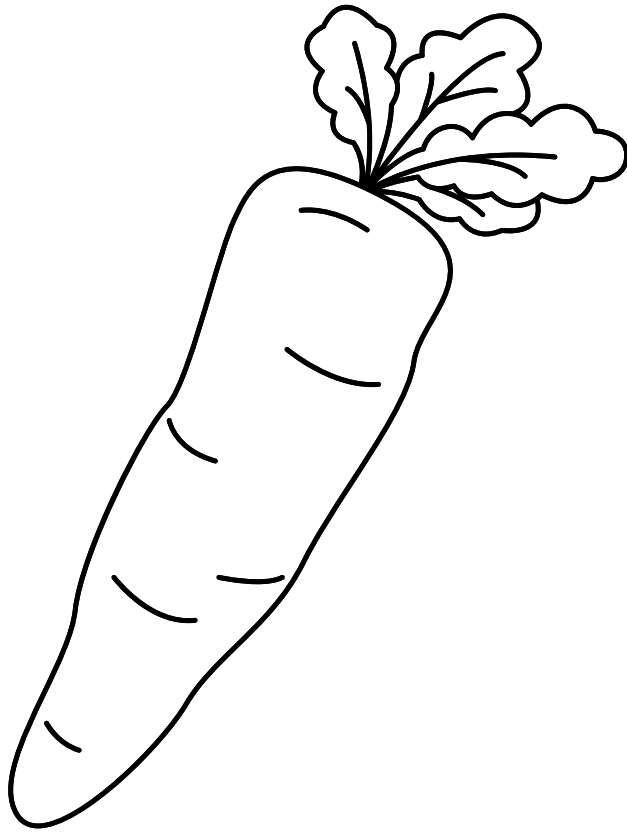

Carrot

Date: -----

Name: -----

Trace the letter

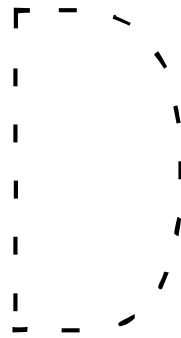
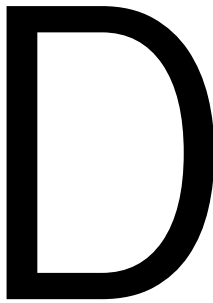
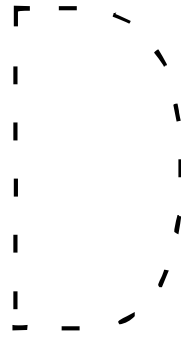

Name: _____

Date: _____

Color the drawing and trace the word

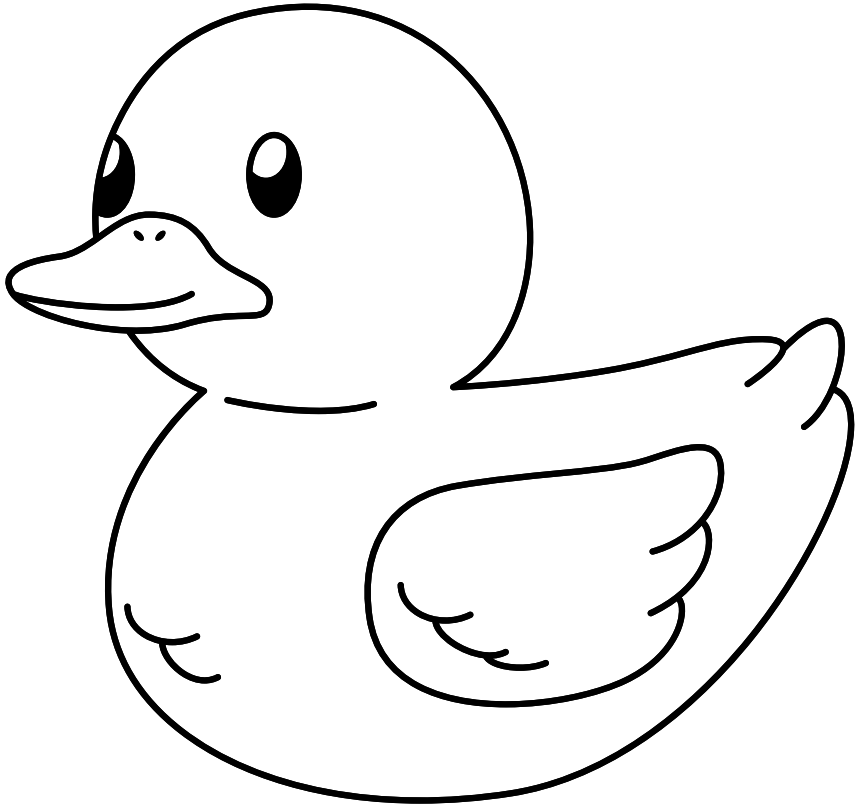

Duck

Date: -----

Name: -----

Trace the letter

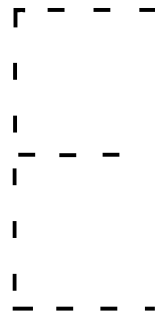
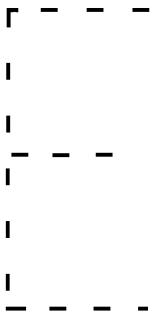
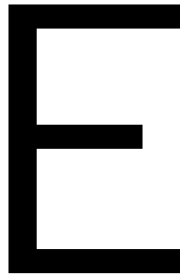
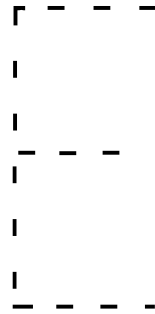
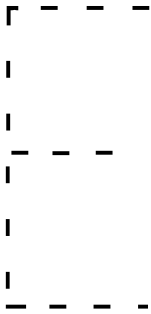

Name: _____

Date: _____

Color the drawing and trace the word

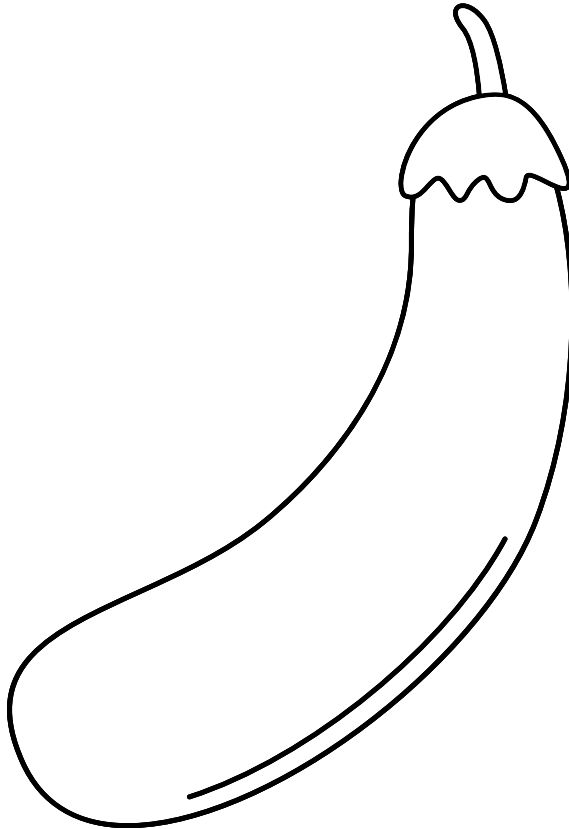

Eggplant

Date: -----

Name: -----

Trace the letter

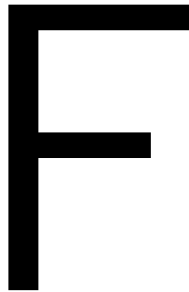

Name: _____

Date: _____

Color the drawing and trace the word

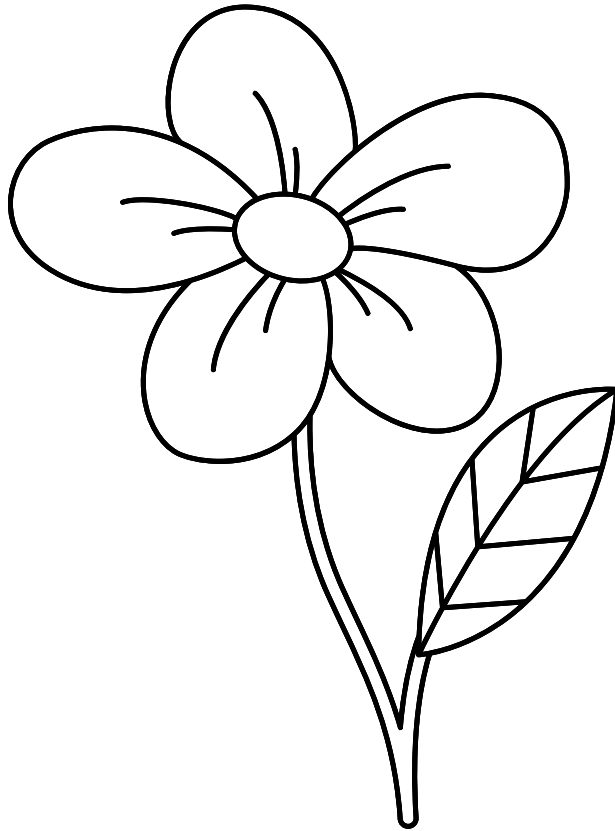

Flower

Date: -----

Name: -----

Trace the letter

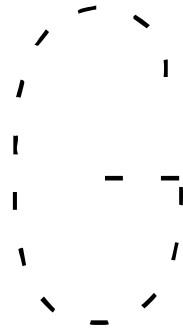
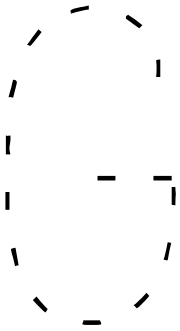
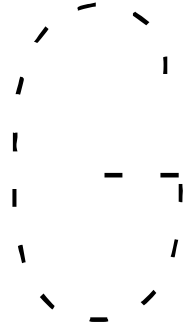
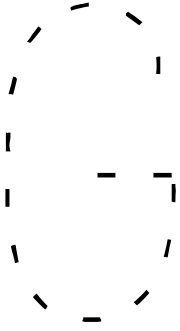

Name: _____

Date: _____

Color the drawing and trace the word

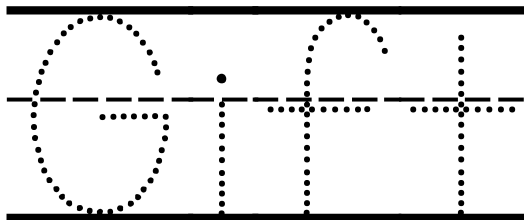
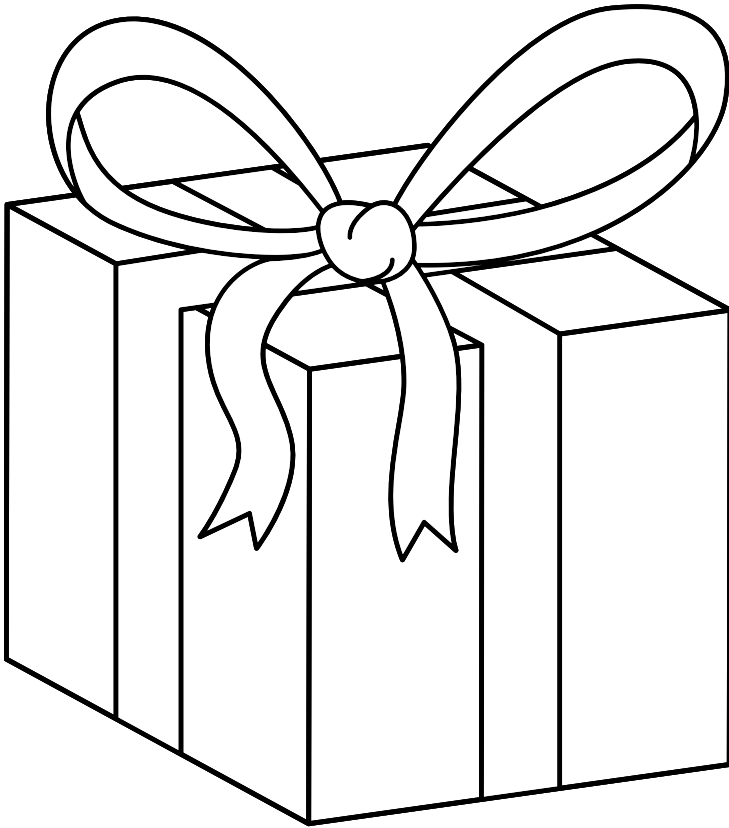

Date: -----

Name: -----

Trace the letter

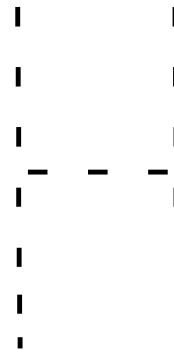
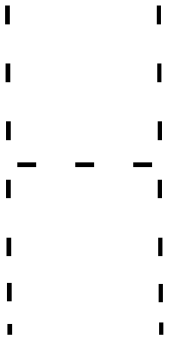
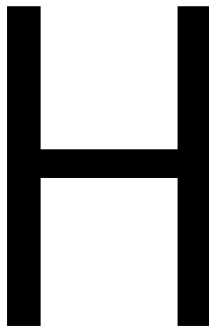
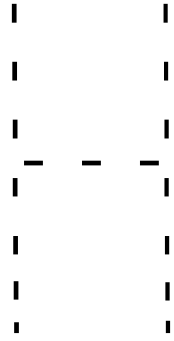
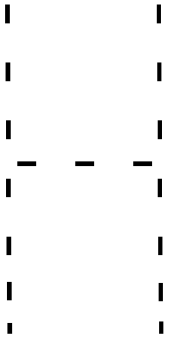

Name: _____

Date: _____

Color the drawing and trace the word

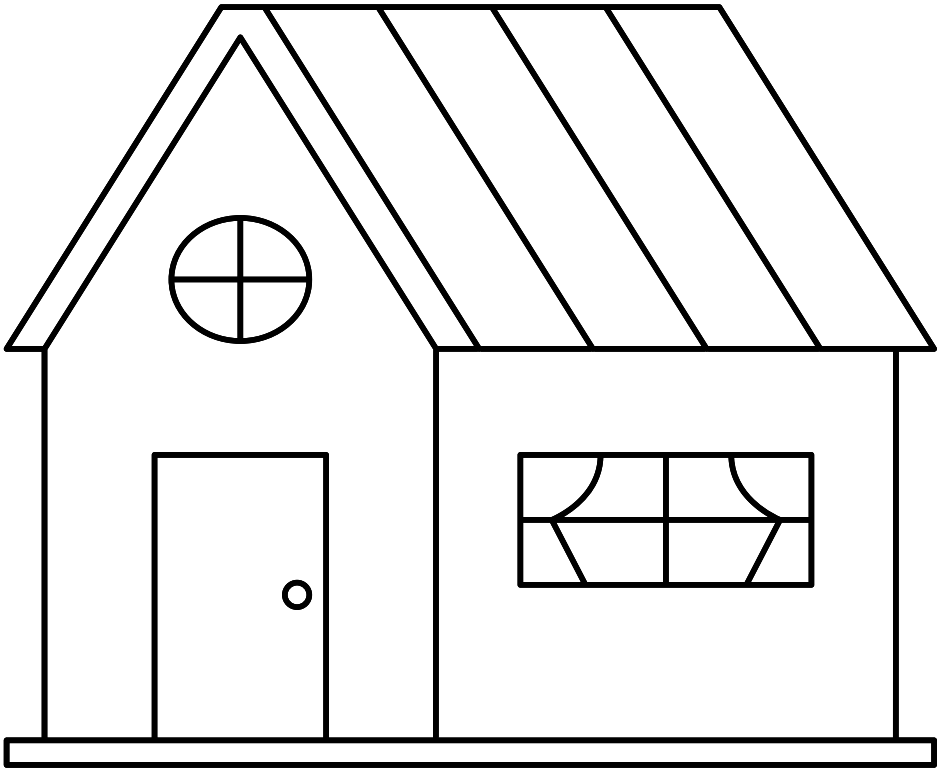

House

Date: -----

Name: -----

Trace the letter

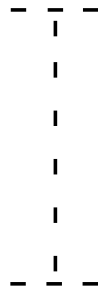
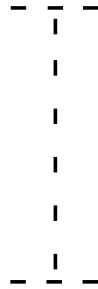

Name: _____

Date: _____

Color the drawing and trace the word

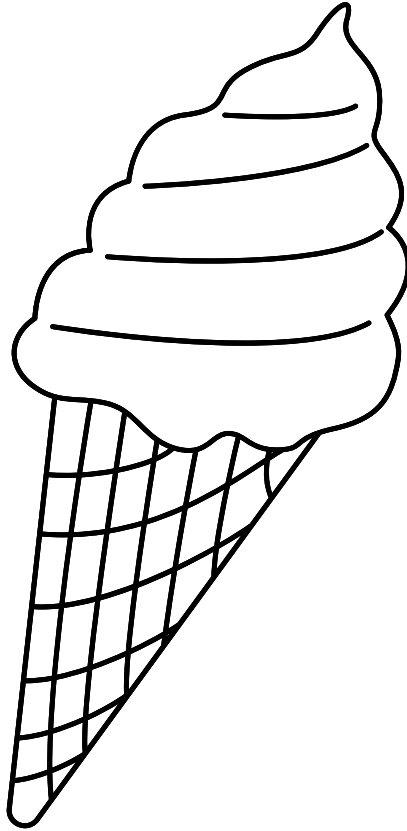

Ice Cream

Date: -----

Name: -----

Trace the letter

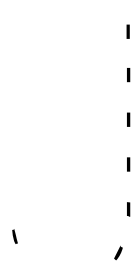
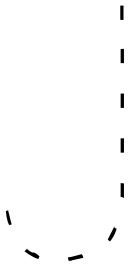
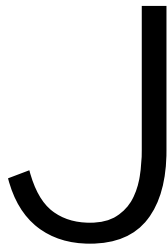
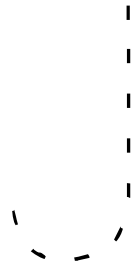
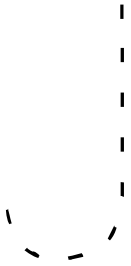

Name: _____

Date: _____

Color the drawing and trace the word

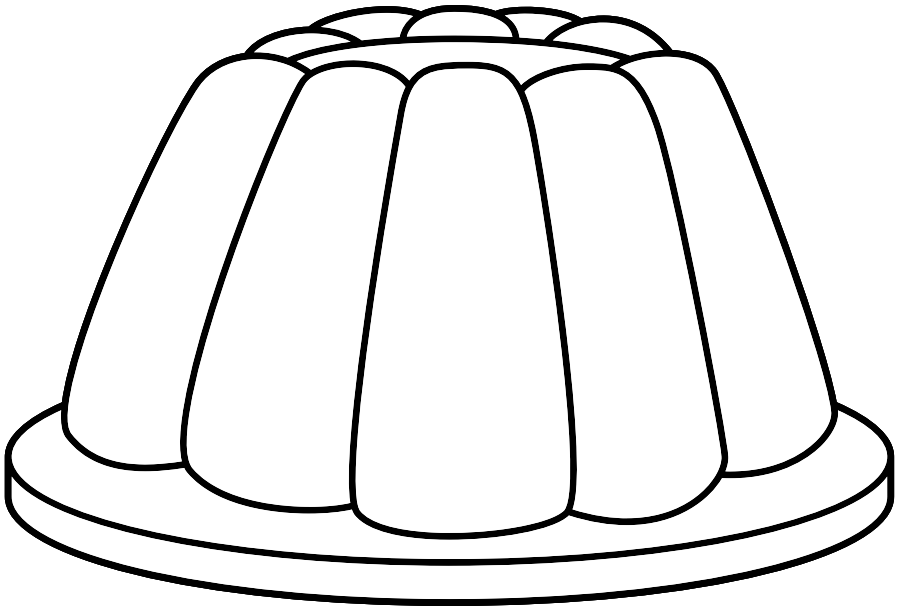

Jelly

Date: -----

Name: -----

Trace the letter

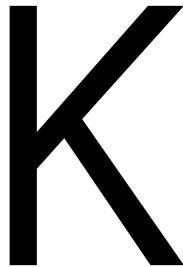
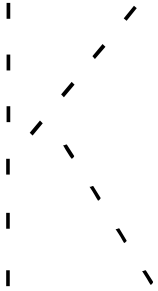

Name: _____

Date: _____

Color the drawing and trace the word

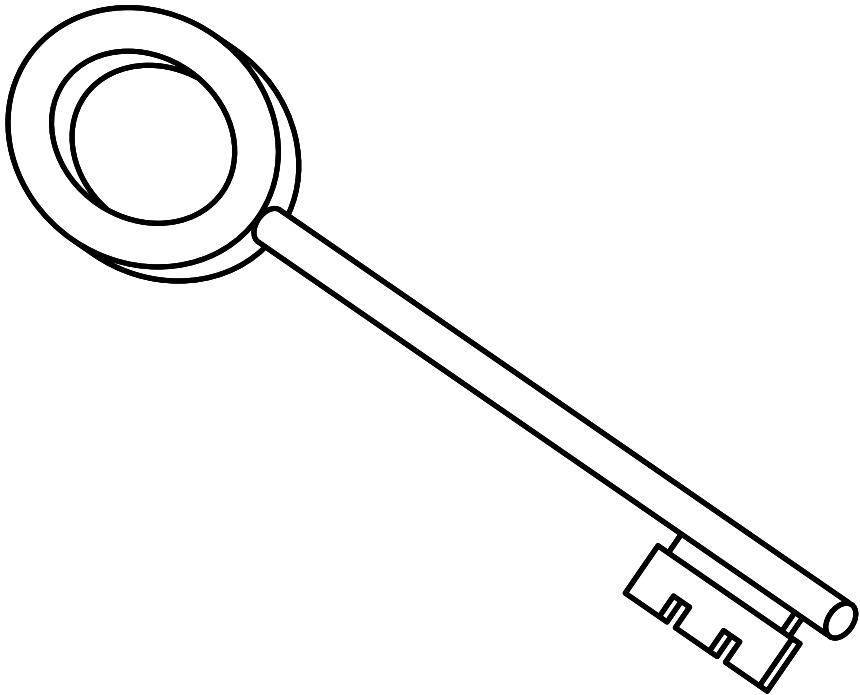

Key

Date: -----

Name: -----

Trace the letter

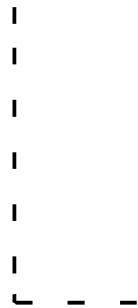
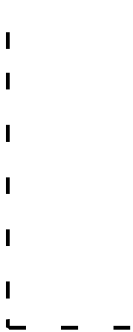
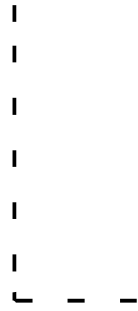

Name: _____

Date: _____

Color the drawing and trace the word

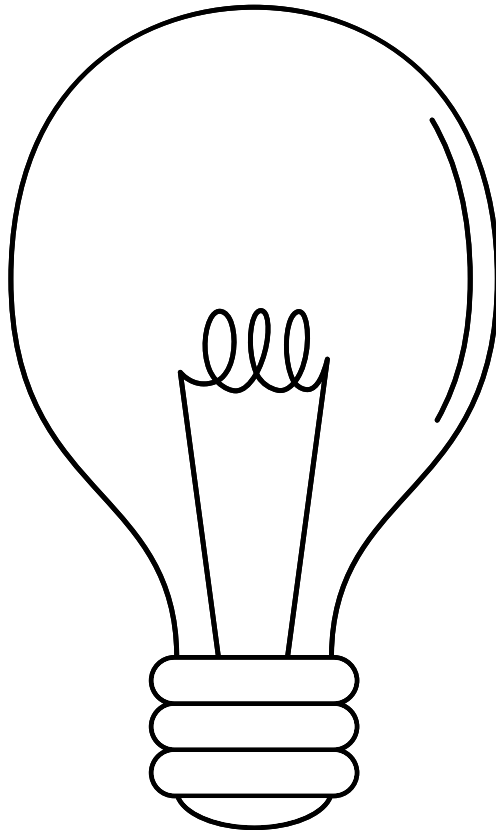

Light Bulb

Date: -----

Name: -----

Trace the letter

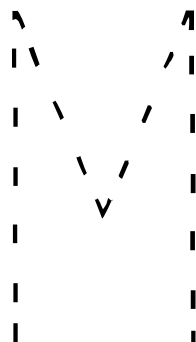
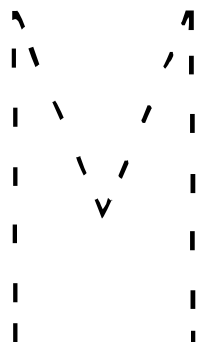
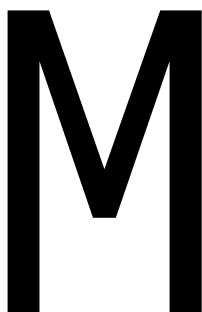
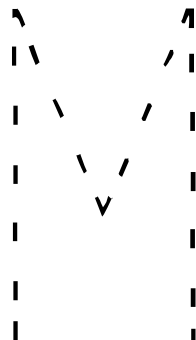
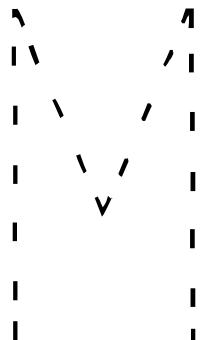

Name: _____

Date: _____

Color the drawing and trace the word

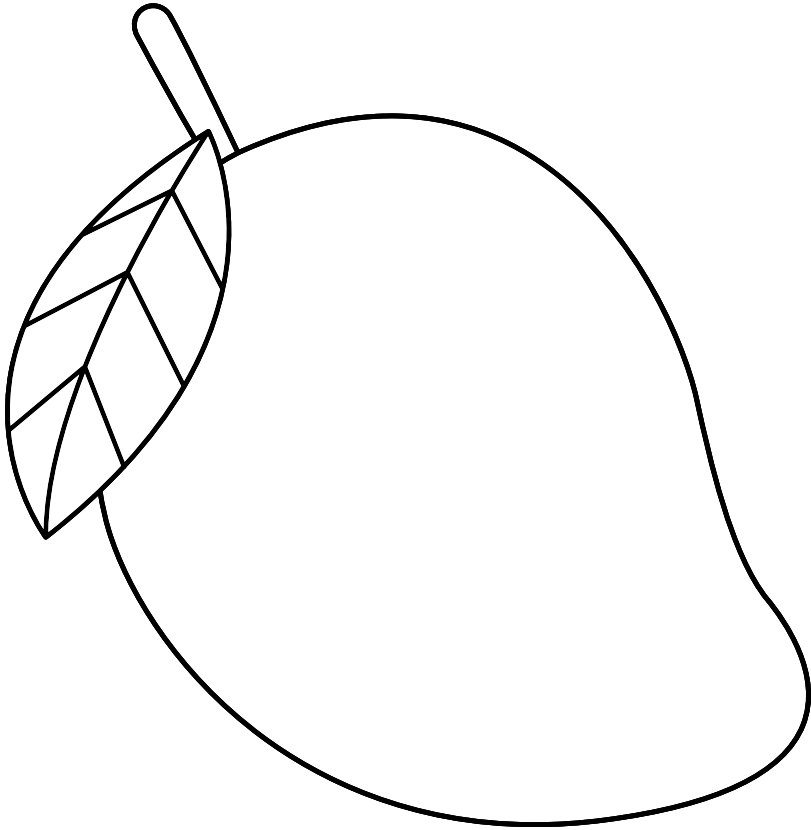

Mango

Date: -----

Name: -----

Trace the letter

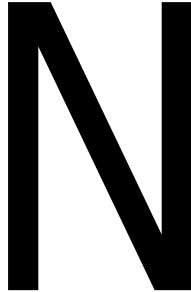

Name: _____

Date: _____

Color the drawing and trace the word

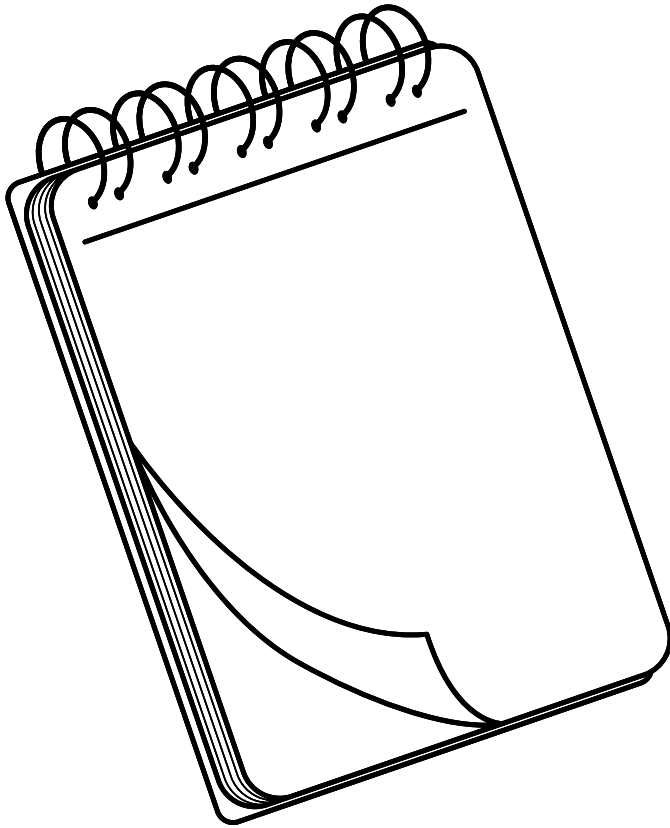

Notepad

Date: -----

Name: -----

Trace the letter

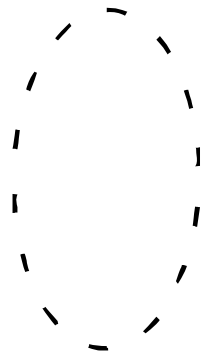
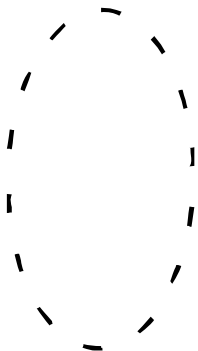
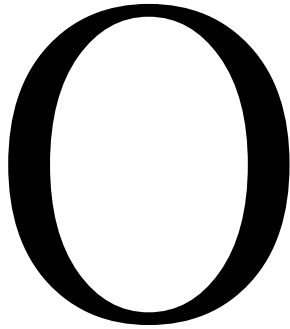
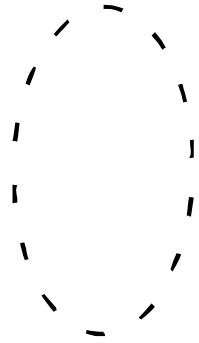
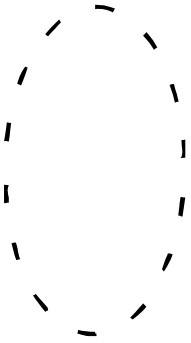

Name: _____

Date: _____

Color the drawing and trace the word

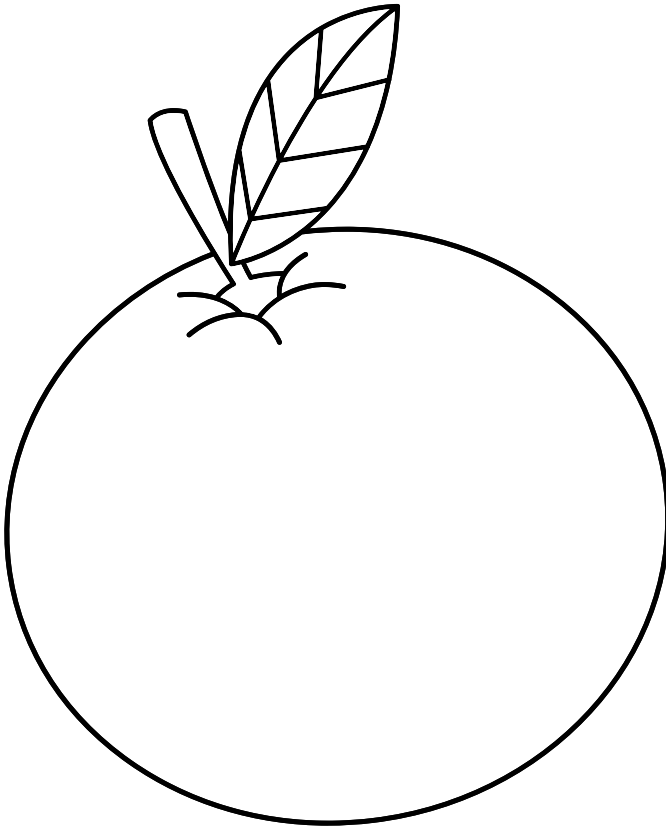

Orange

Date: -----

Name: -----

Trace the letter

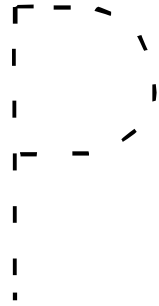
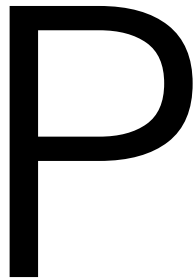
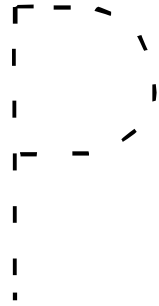
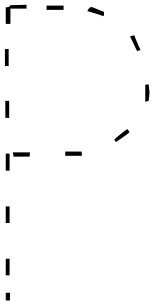

Name: _____

Date: _____

Color the drawing and trace the word

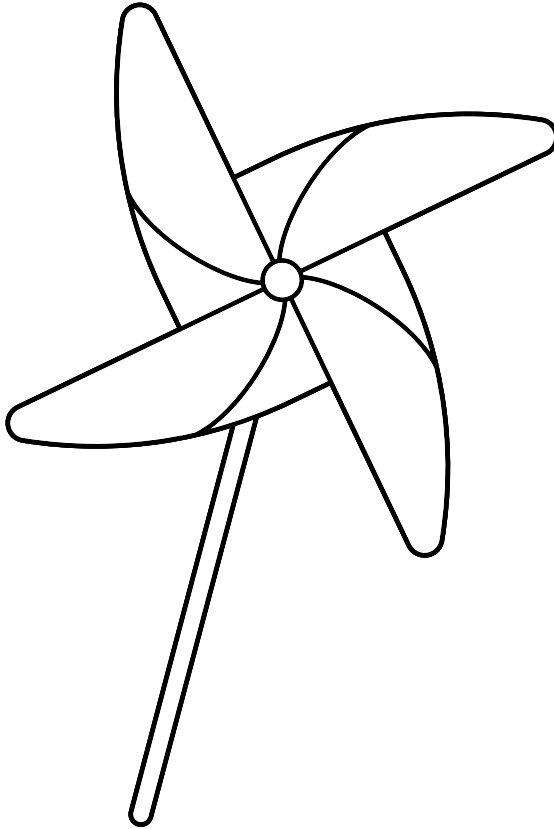

P
Pinwheel

Date: -----

Name: -----

Trace the letter

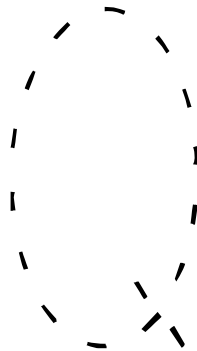
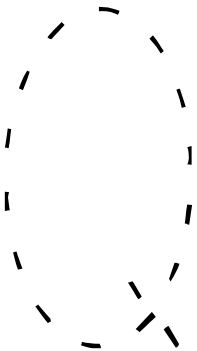
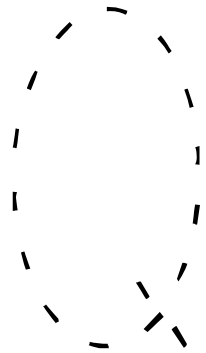
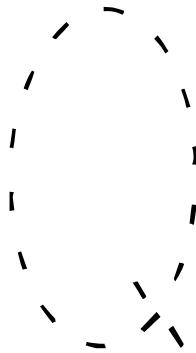
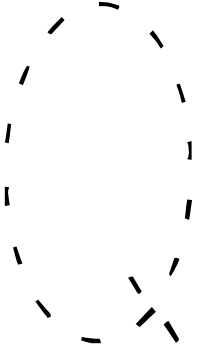

Name: _____

Date: _____

Color the drawing and trace the word

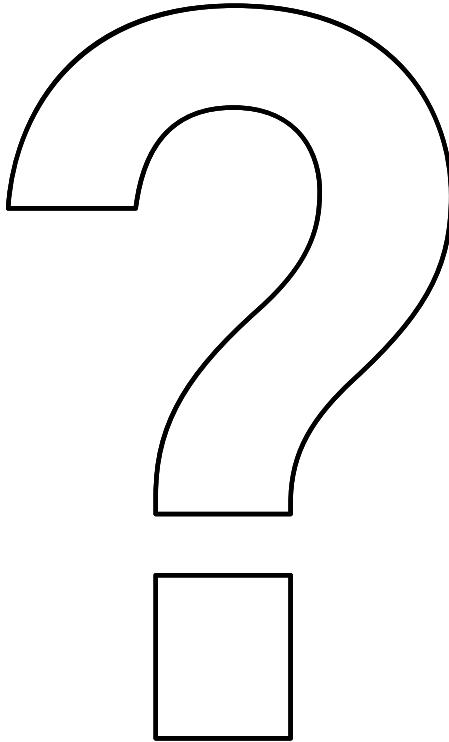

Question

Mark

Date: -----

Name: -----

Trace the letter

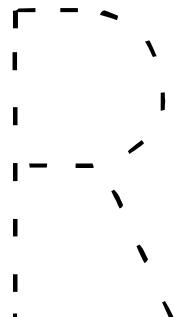
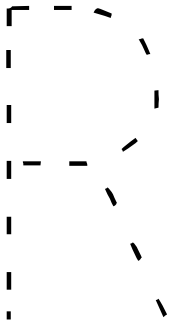
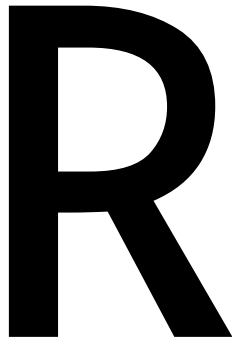
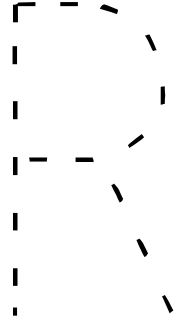
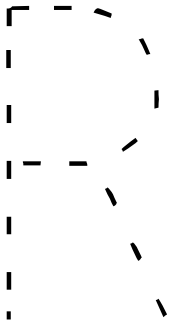

Name: _____

Date: _____

Color the drawing and trace the word

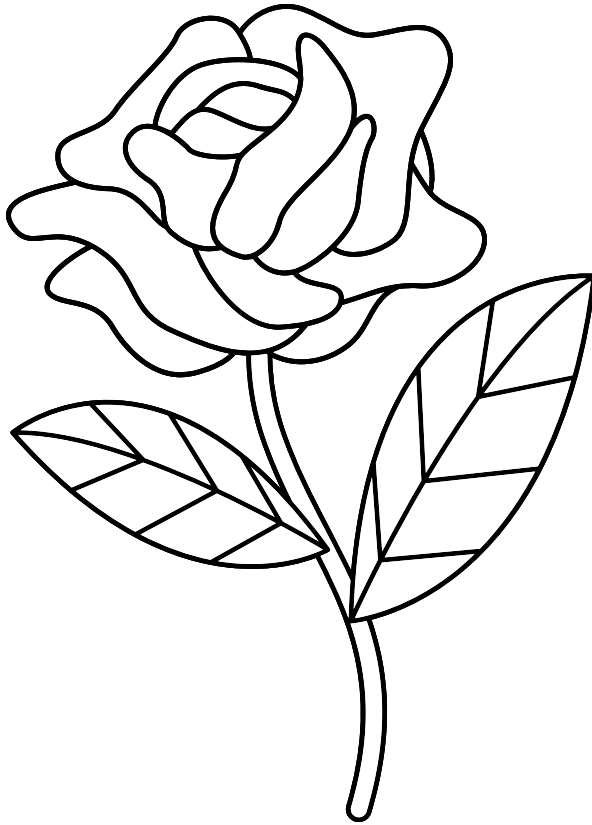

Rose

Date: -----

Name: -----

Trace the letter

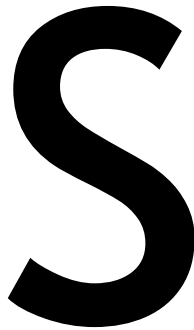

Name: _____

Date: _____

Color the drawing and trace the word

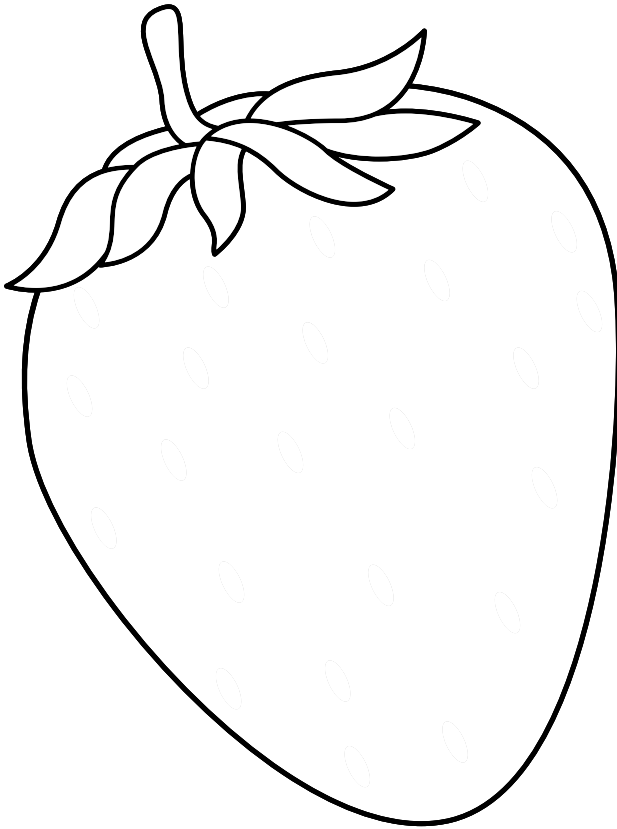

Strawberry

Date: -----

Name: -----

Trace the letter

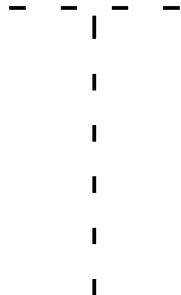
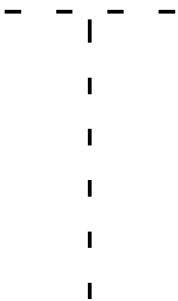
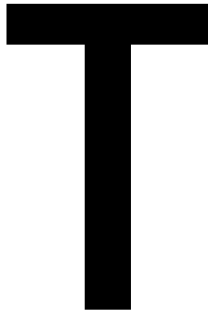
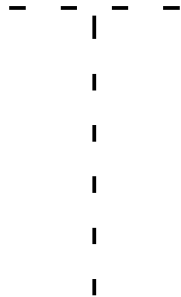
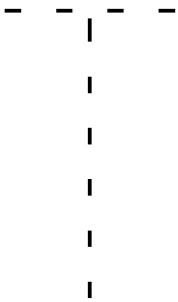

Name: _____

Date: _____

Color the drawing and trace the word

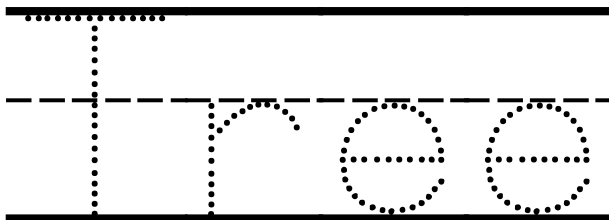
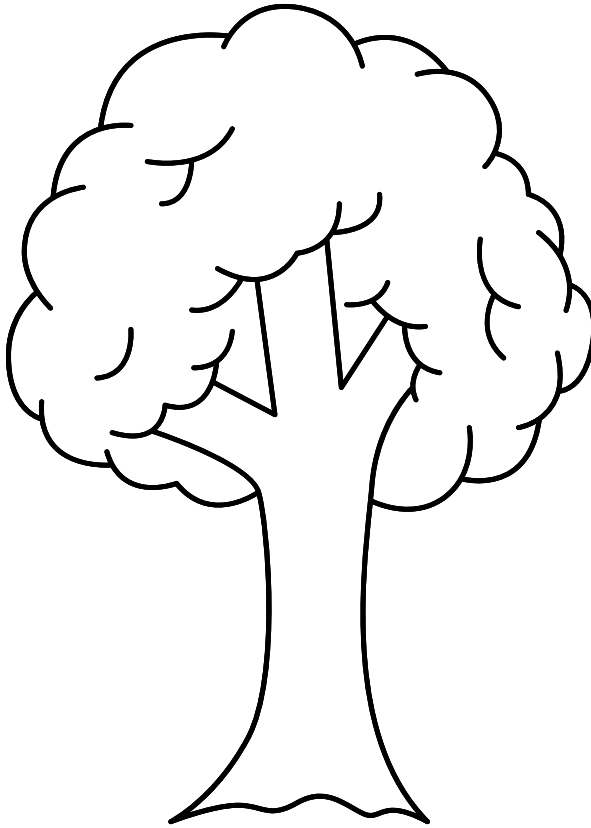

Date: -----

Name: -----

Trace the letter

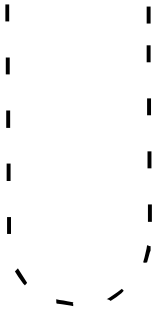
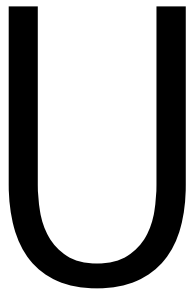
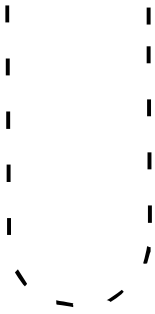

Name: _____

Date: _____

Color the drawing and trace the word

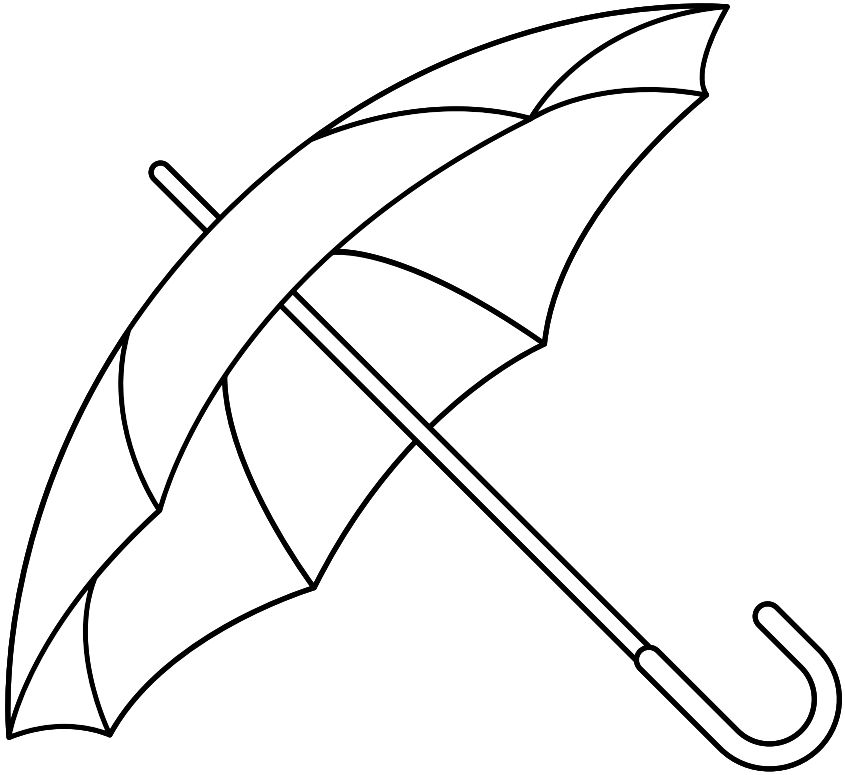

Umbrella

Date: -----

Name: -----

Trace the letter

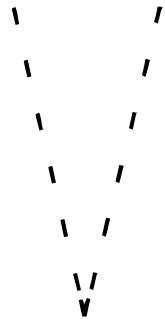
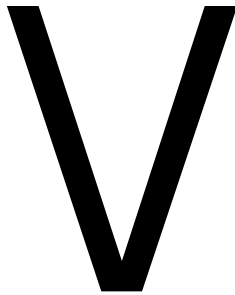

Name: _____

Date: _____

Color the drawing and trace the word

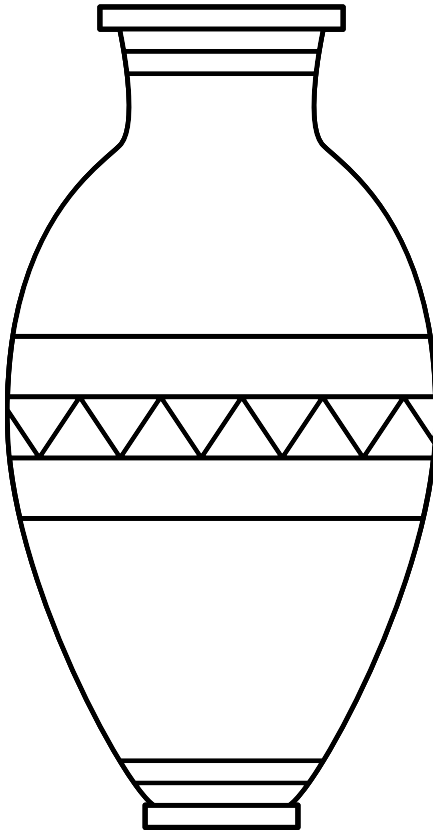

vase

Date: -----

Name: -----

Trace the letter



Name: _____

Date: _____

Color the drawing and trace the word

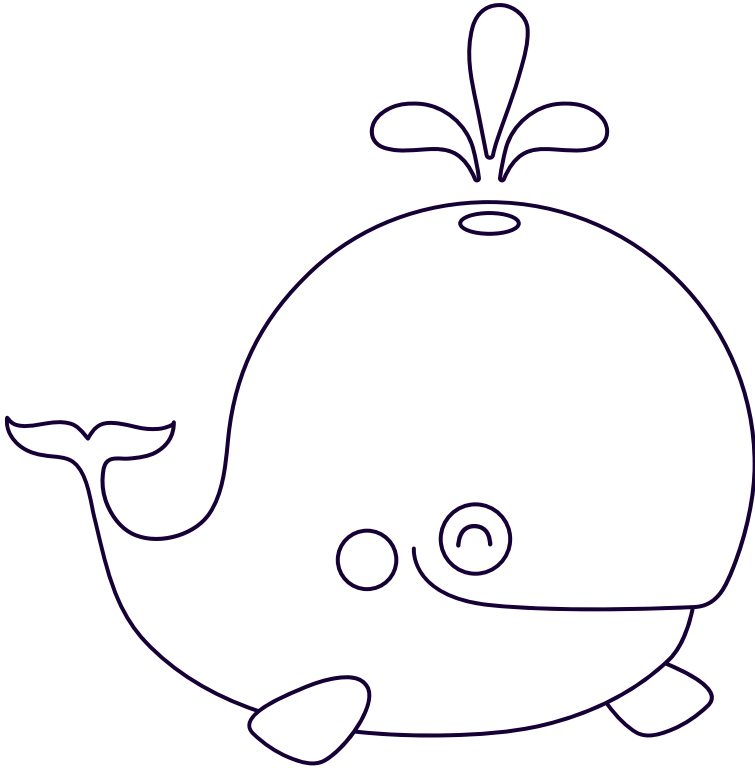

whole

Date: -----

Name: -----

Trace the letter

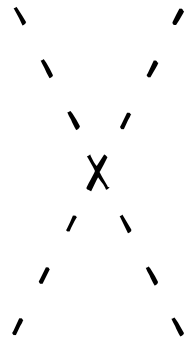

Name: _____

Date: _____

Color the drawing and trace the word

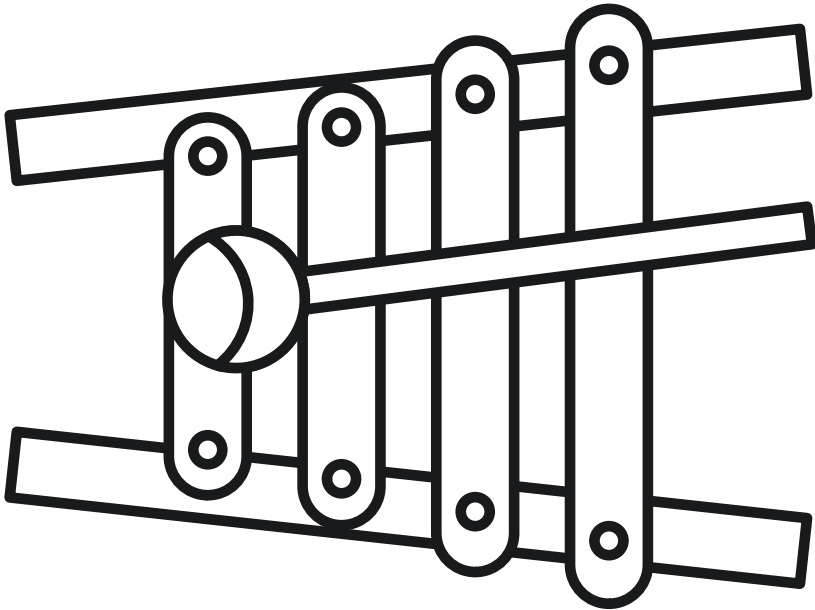

Xylophone

Date: -----

Name: -----

Trace the letter

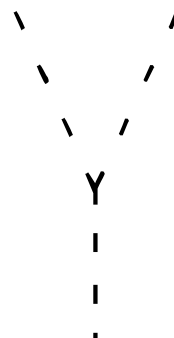

Name: _____

Date: _____

Color the drawing and trace the word

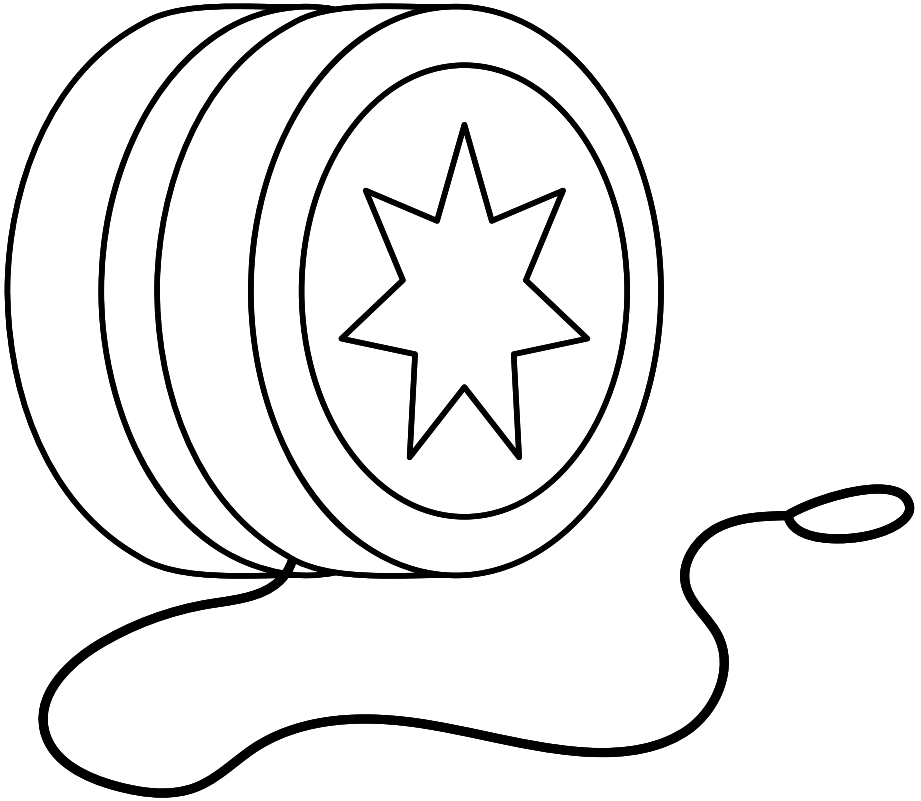

Yoyo

Date: -----

Name: -----

Trace the letter

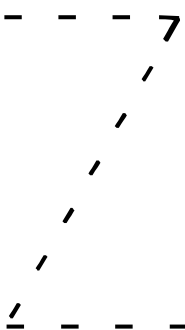
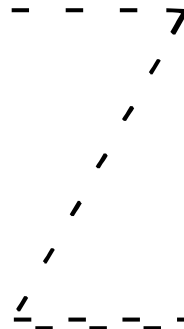
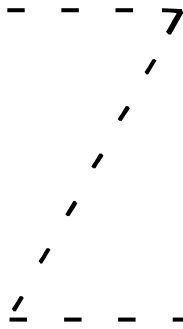
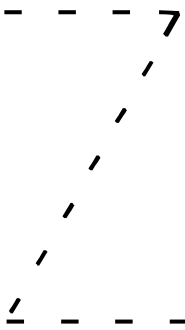

Name: _____

Date: _____

Color the drawing and trace the word

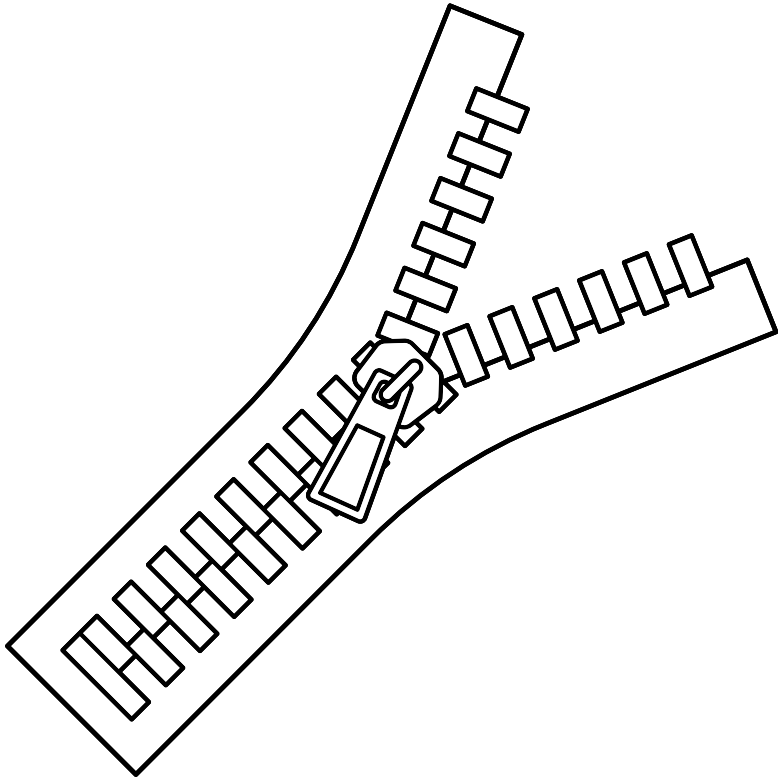

Zipper